

Tank Type: S Tank

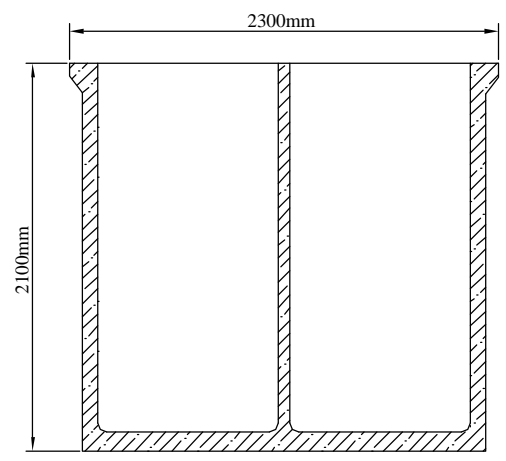

Tank Vertical Section

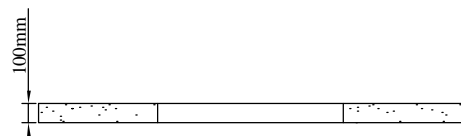
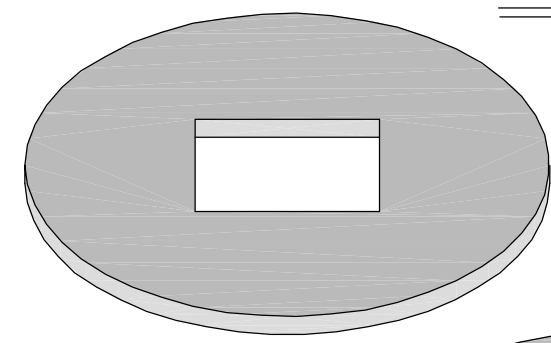

Lid Section

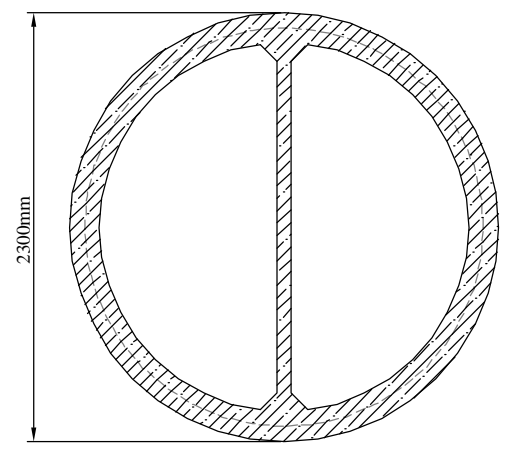

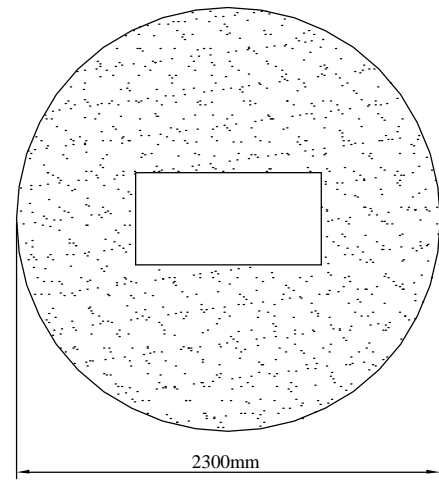

Tank Top Plan

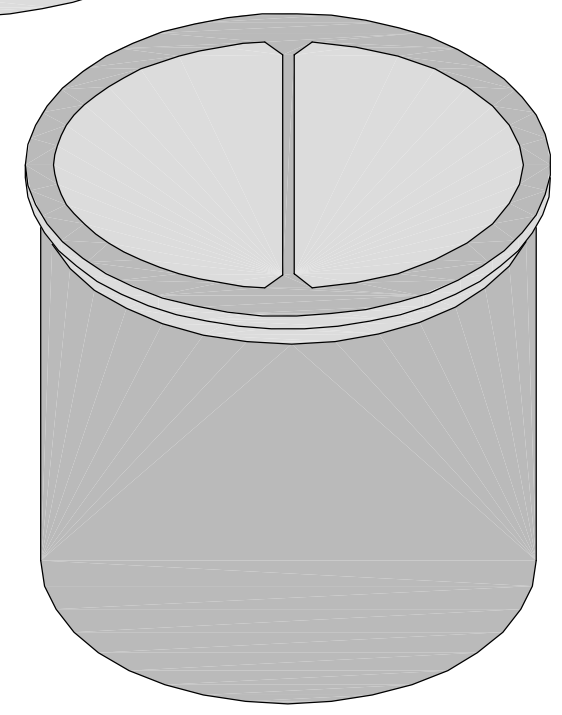
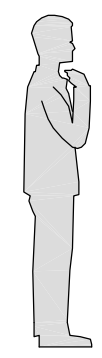

Lid Top Plan

Standard 500mm x 1000mm manhole in center, other sizes and positions to order

E-mail: info@molloyprecast.com
 Web: www.molloyprecast.com

Aswa from **MOLLOY PRECAST**

Molloy Precast Products Ltd. Coleraine, Clara Road, Tullamore, Co.Offaly. Tel: 05793 26000 Fax:05793 26060	Tank Type S Tank Tank Size: 2300mm Diameter Height: 2100mm ex. lid & manhole Volume: 6200 liters Weight: 4200 Kg. ex.lid (Tank Dim: ± 20mm. Weight: ± 30Kg.)
--	---

Note: See reverse for excavation details & safety regulations.

Note: Specify hole drilling requirements. All civil works by customer.

Note: Do NOT scale from drawings. Drawings for illustration purposes only.

This drawing is ©. All rights reserved.